

WM9500 Series

with multipurpose, good environment adaptability and cost savings.



WM9500
High performance and specification model



WM9500αLT
Compact and light weight standard model



WM9500Σ
whole vehicle 3D measurement



WM9500 narda
world standard electromagnetic field measurement (absolute value)

WM9500 series specifications

	WM9500	WM9500αLT	WM9500Σ	WM9500 narda
Scanning method	stereo 3D measurement	stereo 3D measurement	3D measurement with 4 cameras	stereo 3D measurement
Scanning distance ※1	60cm~3m (maximum5m)	30cm~2m (maximum4m)	60cm~3m (maximum5m)	60cm~3m (maximum5m)
Minimum scanning grid size	1mm ³	1mm ³	1mm ³	1mm ³
Scanning accuracy	±1mm (measuring distance 2 m)	±2 mm (measuring distance 2 m)	±1mm (measuring distance 2 m)	±1mm (measuring distance 2 m)
Luminance control	Automatic			
Scanning range (from 2m)	2m	1.5m	wide area	2m
Scanning range (from 3m)	3m	2m	wide area	3m
Probe guide	-	○	-	-
3D Camera	850nm Near-Infrared Camera			
Input voltage	AC100-240V			
Power consumption	under 100VA			
Special software	Control software and viewer software			
Sensor	variety	variety	variety	narda sensors
Spectrum analyzer	variety	variety	variety	dedicated software
Results output	dBm (relative value)	dBm (relative value)	dBm (relative value)	TEST.A / m (absolute -value)
Body (camera) size	400×100×100	270×50×50	54×81×43	400×100×100
Weight ※2	35kg	15kg	-	35kg

※1 the distance from camera to target object ※2 including camera, computer, cable and packing box

Manufacturer



Morita Tech Co., Ltd.

T: 206-0804
2113-4, Morita, Inagi-shi, Tokyo, 206-0804, JAPAN
TEL : 042-401-6330 FAX : 042-401-6331
e-mail : info@morita-tech.co.jp HP : www.morita-tech.co.jp



Distributor

The EMC noise measurements of all industries are applicable.



Unique 6 axis 3D measurement

3D spatial electromagnetic field visualization system

WM9500 Series



WM9500



WM9500αLT



High performance and specification scanner

WM9500

WM9500Σ



WM9500 narda



Compact and light weight standard model

WM9500αLT

A 360-degree scanning model

WM9500Σ

narda model

WM9500 narda



Can measure kinds of equipments includes the whole vehicle



vehicle



intelligent Device



household appliances

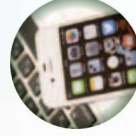

communication equipment



machinery for industry

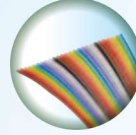

PCB, cable



Morita Tech Co., Ltd.

The only one professional tool that can identify the action and orientation of the sensor through 6 axis 3D measurement to figure out the reason of the EMC.

Since it went on sale from 2013, the engineers from vehicle industry、household appliance industry and Machinery manufacturers highly rated WM 9500 series, which can realize the spatial electromagnetic field visualization via unique 6 axis 3D measuring method. Realizing the high measuring accuracy by identifying the action and orientation of the probe by using the 6 axis 3D measuring method that not only includes X、Y、Z axis, but also includes θX 、 θY and θZ axis. And, in order to meet more needs of the business sites, 4 products of WM 9500 series are lineup. There is no requirements for measuring purpose and site environment.

4 advantages of WM9500 series

[1.6 axis 3D measuring]

Realizing 6 axis 3D measurement. Through exactly capturing the spatial slope to reduce the measurement error due to the attenuation of sensor sensitivity. And the offset of the spatial position from the marker ball to the sensor can be modified.

[2.easy to operate]

Because of using the near-infrared to identify the coordinates. Therefore, it is not affected by the brightness and color of the object, the stable and accurate measurement is available. Moreover, the setting will just take about 10 minutes to complete.

[3. freely combined]

It is composed of 3D camera, control unit, positioning ball, notebook computer and special software. The spectrometer and antenna can be combined freely.

[4. strong lineup]

We have 4 products to choose from, all of them have the characteristics of wide measuring distance and range (omnidirectional measuring), compact and movable, human body protection and absolute value measurement and so on. Please choose a model that is most suitable for your use and the object under test, site conditions and budget.

※ X、Y、Z、 θX 、 θY 、 θZ

WM9500 Series

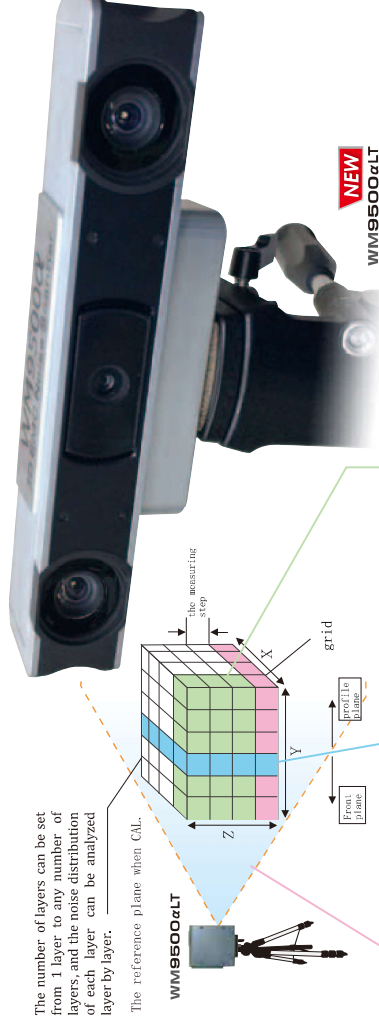

The number of layers can be set from 1 layer to any number of layers, and the noise distribution of each layer can be analyzed layer by layer.

The reference plane when CAL.

WM9500 α LT

NEW
WM9500 α LT

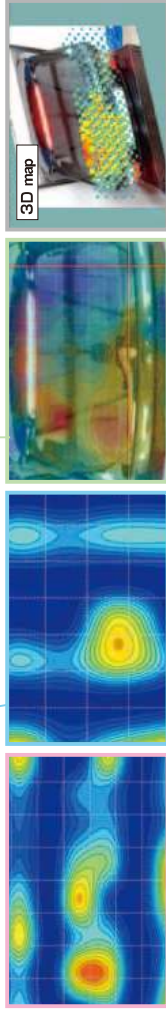

Any section of X-Y, X-Z, Y-Z can be extracted to look the source and distribution of noise through the visualization of data.

Realizing 3D measurement of a wide frequency band from DC to 60GHz

Through the replacement of the probe and sensor, the 3D measurement of electromagnetic wave in different frequency range is realized, which can cover all the items needed to be tested in the EMC measurement site, such as the measurement of sound pressure and ultrasonic wave, the measurement of magnetic field and electric field, and the measurement from circuit board to vehicle and so on. Morita technology has developed its own probe and sensor to maximize the performance of wm9500. In addition, the combination of wm 9500 marda and 3-axis probe with international standards can realize electromagnetic field measurement from DC to 60GHz.

The visualization of 3D spatial noise can be realized for both finished products and components

The WM9500 series has four models that meet the customer's use and budget. Moreover, the range of EMC measurement can be further expanded by combining with probe sensor and other products. For example, parts such as automobile engine, trunk, exterior and interior decoration that are suspected to be the source of noise can be tested, and the whole vehicle can be scanned for testing. In addition, through the use of 3D positioning marks, 3D noise measurement of components (circuit boards, etc.) can also be realized.

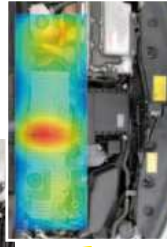

After the scanning antenna is used to map the space of the trunk along the shape of the trunk, the cross-sectional view of the noise can be extracted and viewed separately.

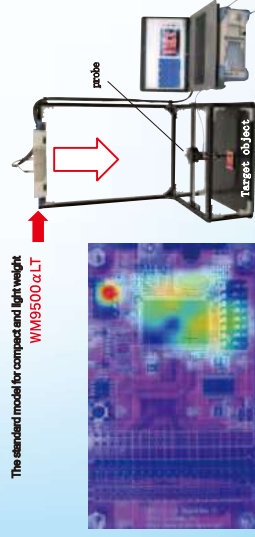

The standard model for compact and light weight
WM9500 α LT

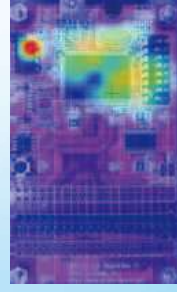

Through using of wm9500 α LT and probe guide, 3D electromagnetic noise of circuit board or electrical module can be measured and visualized.

DC 60GHz



10Hz-100kHz

[Sound press, Ultrasonic distribution.]



9kHz-250kHz (SRM-3006) DC-1kHz (FHM176)
10Hz-400kHz (ELT-400) 100kHz-60GHz (NMB-520/550)

[human protection from electromagnetic field]



100kHz-1GHz

[Electromagnetic field measurement of circuit board and engine room, electromagnetic boundary distribution inside and outside vehicle room, and sensitivity setting of intelligent entry system]



1GHz-6GHz

[Measurement of space electric field distribution by using mini-biconical electric field antenna]

▲ MBA203 (Microwave Factory Co.Ltd)



WM9500 Σ can measure the whole vehicle. In this way, it is relatively simple to explore the place and cause of EMC.